

OLYMPUS[®]

Your Vision, Our Future

Semiconductor/ FPD/ Industrial
Inspection Microscopes

MX63/MX63L

High Efficiency, Advanced Imaging

NEW



Ergonomic Microscopy with Advanced Imaging Capabilities



The MX63 and MX63L microscope systems offer quality observations for up to 300 mm wafers, flat panel displays, printed circuit boards, and other large samples. These ergonomic and user-friendly systems feature a modular design, enabling optimal observation conditions in diverse applications. When combined with OLYMPUS Stream image analysis software, the inspection workflow is simplified and streamlined, from observation to report generation.



Functions marked with this icon require OLYMPUS Stream software

Meeting the Needs of the Electronics Industry

Functional

Designed to meet the ergonomic and safety requirements of the electronics industry with added functionality to enhance analysis capabilities.

User-Friendly

Simplified microscope settings makes it easier for users to make adjustments and reproduce system settings.

Advanced Imaging Technology

Our proven optics and exceptional imaging technology deliver clear images and reliable inspections.

Modular

Users can customize their system with the components that suit their application.

Functionality

Advanced Analysis Tools

The MX63 series' various observation capabilities provide clear, sharp images so users can reliably detect defects in their samples. New illumination techniques and image acquisition options within OLYMPUS Stream image analysis software give users more choices for evaluating their samples and documenting their findings.

The Invisible Becomes Visible: MIX Observation and acquisition

MIX observation technology produces unique observation images by combining darkfield with another observation method, such as brightfield, fluorescence, or polarization. MIX observation enables users to view defects that are difficult to see with conventional microscopes. The circular LED illuminator used for darkfield observation has a directional darkfield function where only one quadrant is illuminated at a given time. This reduces a sample's halation and is useful for visualizing a sample's surface texture.

Structure on semiconductor wafer

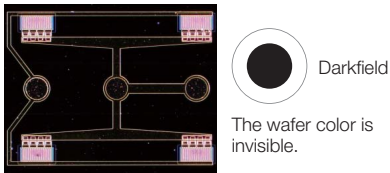
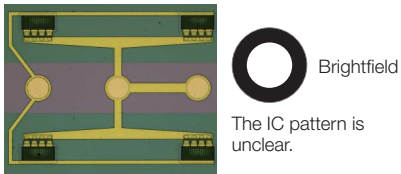

Photoresist residue on a semiconductor wafer

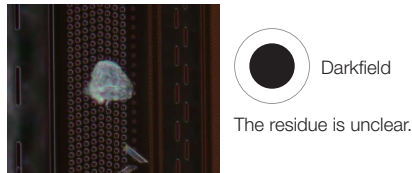
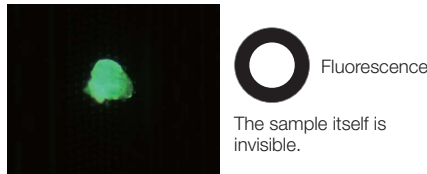

Condenser

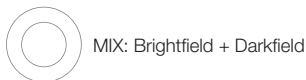
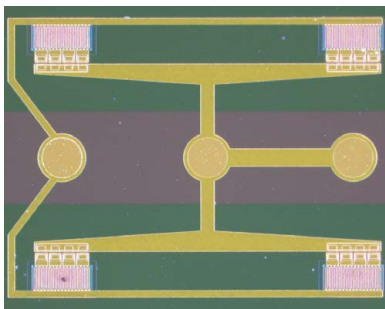
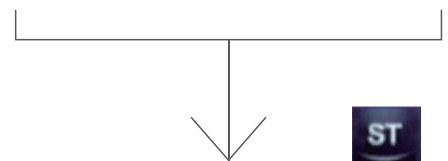
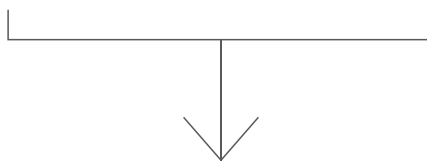
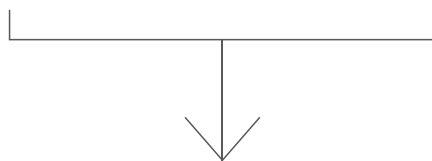
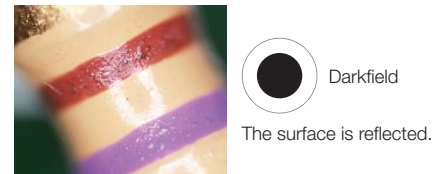

Both the wafer color and IC pattern are clearly represented.

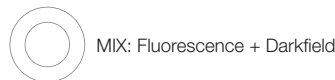
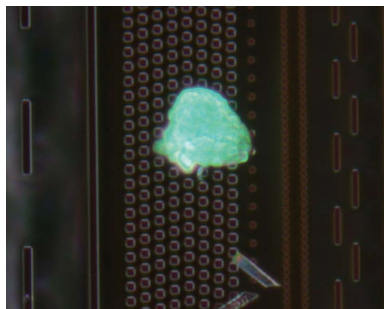

Both the IC pattern and residue are clearly represented.



Composite image of several images with directional darkfield from different angles.

By stitching together clear images with no halation, a single crisp image of the sample is created.

Easily Create Panoramic Images: Instant MIA



With multiple image alignment (MIA), users can stitch images together quickly and easily simply by moving the KY knobs on the manual stage—a motorized stage is not necessary. OLYMPUS Stream software uses pattern recognition to generate a panoramic image, giving users a wider field of view.

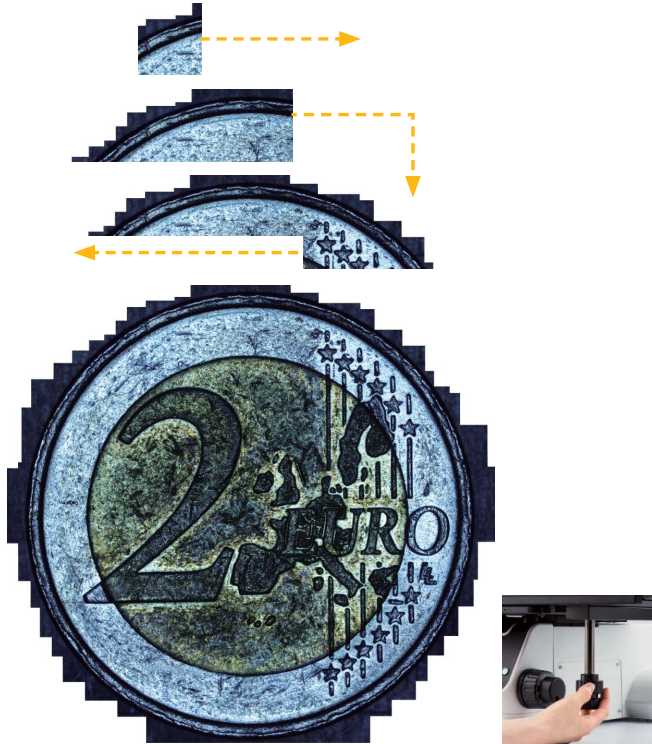

Instant MIA image of a coin

Create All-in-Focus Images: EFI



OLYMPUS Stream software's extended focus imaging (EFI) function captures images of samples whose height extends beyond the depth of focus. EFI stacks these images together to create a single all-in-focus image of the sample. EFI works with either a manual or motorized Z-axis and creates a height map to easily visualize structures. EFI images can be constructed offline within OLYMPUS Stream desktop software.

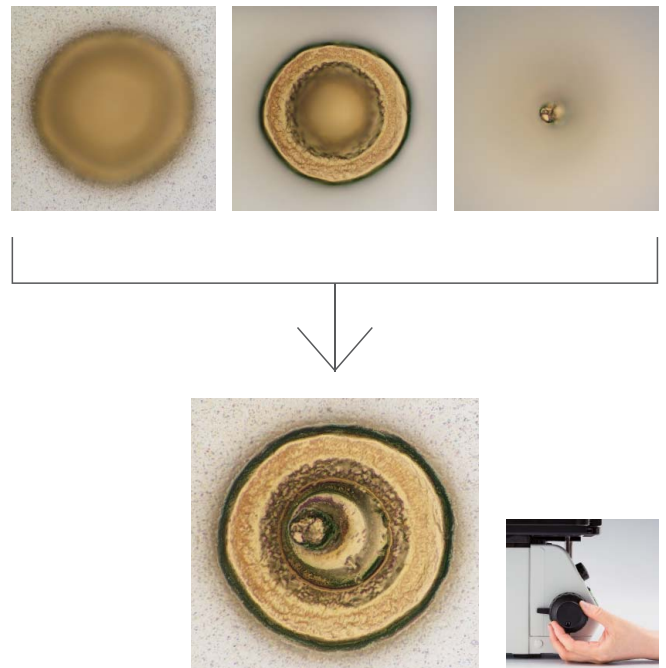

Stud bump on an IC chip

Capture Both Bright and Dark Areas Using HDR



Using advanced image processing, high dynamic range (HDR) adjusts for differences in brightness within an image to reduce glare. HDR improves the visual quality of digital images thereby helping to generate professional-looking reports.

Metal parts on a printed circuit board

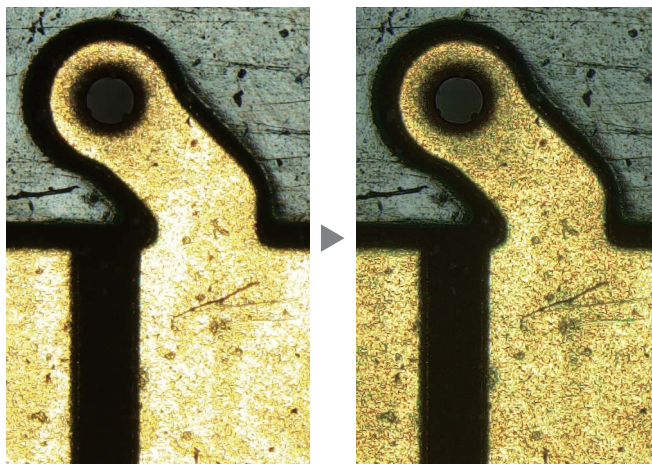

Some areas are glaring.

Both dark and bright areas are clearly exposed by HDR.

FPD

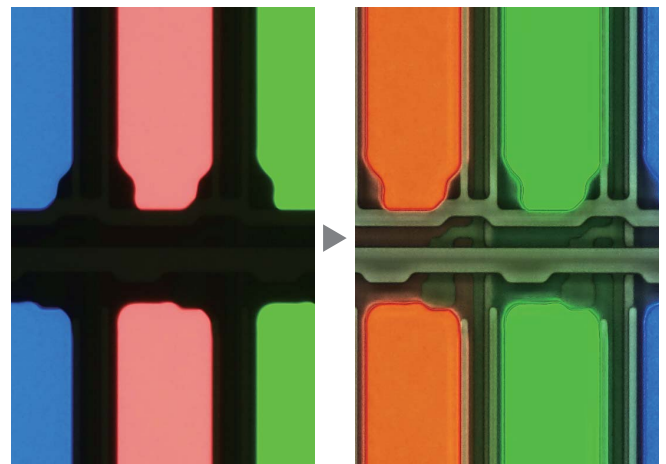

The TFT array is blacked out due to the brightness of the color filter.

The TFT array is exposed by HDR.



From Basic Measurement to Advanced Analysis

Measurement is essential to quality and process control and inspection. With this in mind, even the entry-level OLYMPUS Stream software package includes a full menu of interactive measurement functions, with all measurement results saved with image files for further documentation. In addition, the OLYMPUS Stream Materials Solution offers an intuitive, workflow-oriented interface for complex image analysis. At the click of a button, image analysis tasks can be executed quickly and precisely. With a considerable reduction in processing time for repeated tasks, operators can concentrate on the inspection at hand.

Pattern on a printed circuit board

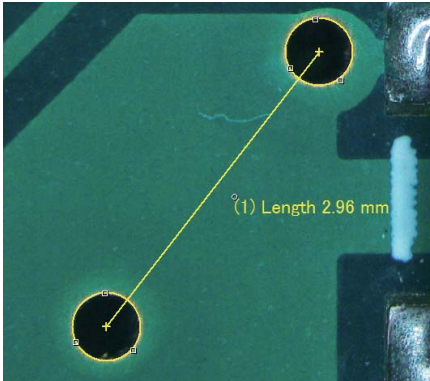

Basic measurement

Cross section of a through hole of printed circuit board

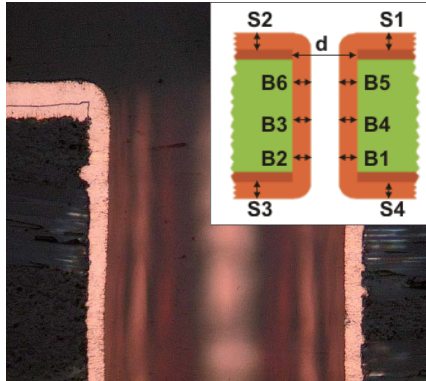

Throwing power solution

Wafer structure

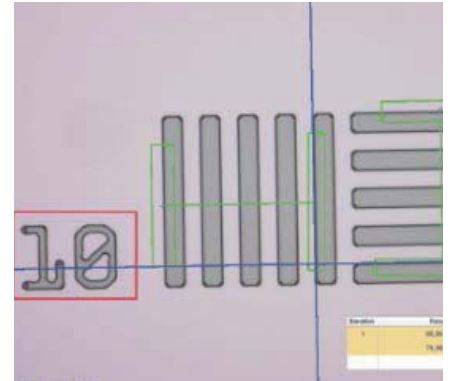

Automatic measurement solution

Efficient Report Creation



Creating a report can often take longer than capturing the image and taking the measurements. OLYMPUS Stream software provides intuitive report creation to repeatedly produce smart and sophisticated reports based on pre-defined templates. Editing is simple and reports can be exported to Microsoft Word or PowerPoint software. In addition, OLYMPUS Stream software's reporting function enables digital zooming and magnification on acquired images. Report files are a reasonable size for easier data exchange by email.

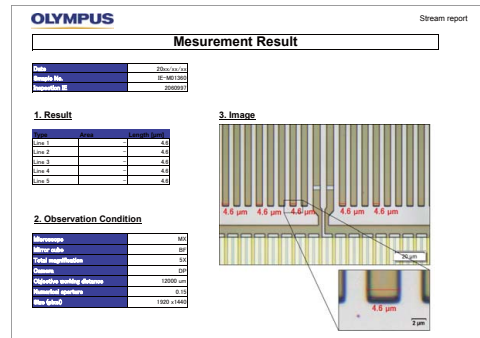
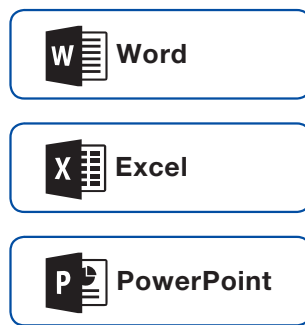
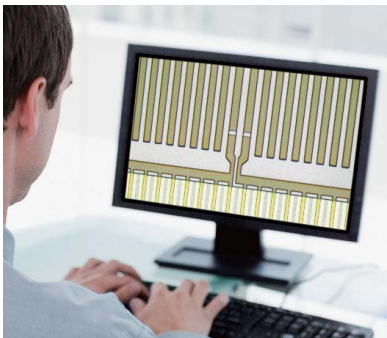

Stand-Alone Camera Option

Using a DP22 or DP27 microscope camera, the MX63 series becomes an advanced stand-alone system. The cameras can be controlled via a compact box that requires less space, helping users maximize their laboratory space while still capturing clear images and making basic measurements.

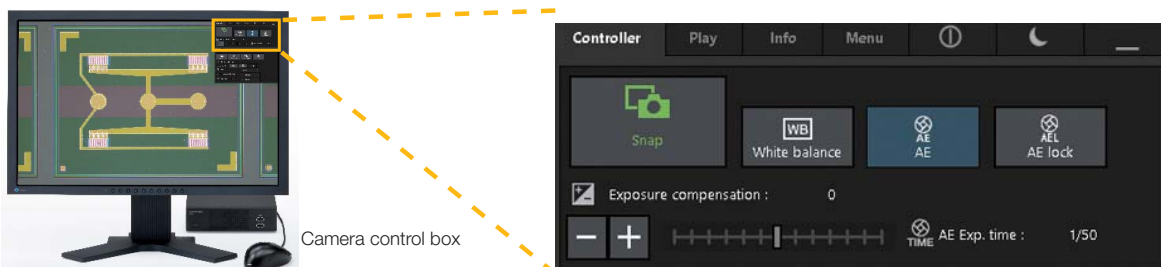

Advanced Designed to Support Cleanroom Conformity

The MX63 series is designed to work in a cleanroom and has features that help minimize the risk of contaminating or damaging samples. The system has an ergonomic design that helps keep users comfortable, even during prolonged use. The MX63 series conforms to international specifications and standards, including SEMI S2/S8, CE, and UL.

Optional Wafer Loader Integration — AL120 System*

An optional wafer loader can be attached to MX63 series to safely transfer both silicon and compound semiconductor wafers from a cassette to the microscope stage without using tweezers or wands. Renowned performance and reliability enable safe, efficient front and back macro inspections while the loader helps improve productivity in the laboratory.

* The AL120 system is not available in Europe.



MX63 system combined with the AL120 wafer loader (200 mm version)

Fast, Clean Inspections

The MX63 series delivers contamination-free wafer inspections. All motorized components are housed in a shielded structure, and antistatic processing is applied to the microscope frame, tubes, breath shield, and other parts.

The rotation speed of the motorized nosepieces is faster and safer than manual nosepieces, decreasing the time between inspections while keeping the operator's hands below the wafer, reducing potential contamination.



Antistatic breath shield



Motorized nosepiece

System Design Achieving Efficient Observations

The XY stage is capable of both coarse and fine stage movements thanks to the combination of a built-in clutch and the XY knobs. The stage helps make observations efficient, even for large samples, such as 300 mm wafers.

The tilting observation tube's extensive range enables operators to sit at the microscope in a comfortable posture.



Stage handle with built-in clutch

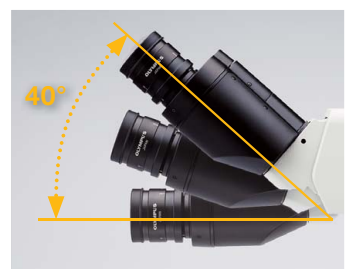

The tilting observation tube enables a comfortable posture

Accepts All Wafer Sizes

The system works with various types of 150–200 mm and 200–300 mm wafer holders and glass plates. Should the size of the wafers change on the production line, the microscope's frame can be modified with small budget. With the MX63 series, different stages can be used to accommodate 75 mm, 100 mm, 125 mm, and 150 mm wafers on the inspection line.



Wafer holders and glass plates

User-Friendly

Intuitive Microscope Controls: Comfortable and Easy to Use

The microscope's settings are simple to operate, making it easier for users to make adjustments and reproduce system settings.

Find the Focus Quickly: Focus Aid

Inserting a focus aid in the optical path enables easy and correct focusing on low-contrast samples, such as bare wafers. Focusing on the grid in the focal plane makes it simple to bring your sample into focus.

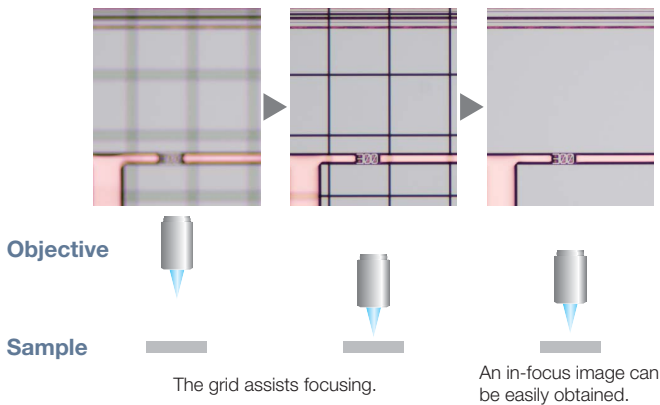

Easily Restore Microscope Settings: Coded Hardware



Coded functions integrate the MX63 series' hardware settings with OLYMPUS Stream image analysis software. The observation method, illumination intensity, and magnification are automatically recorded by the software and stored with the associated images. Since the settings can easily be reproduced, any operator can conduct the same quality inspections with limited training.



X Different operators use different settings.

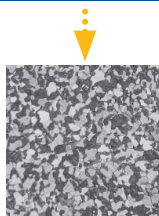
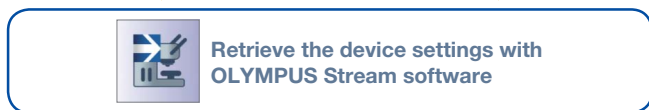

✓ All operators can use the same settings.

Faster Observations via the Light Intensity Manager and Automatic Aperture Control

In normal microscopes, users need to adjust the light intensity and aperture for every observation. The MX63 series enables users to set up the light intensity and aperture conditions for different magnifications and observation methods. These settings can be easily recalled, helping users save time and maintain exceptional image quality.

Light Intensity Manager

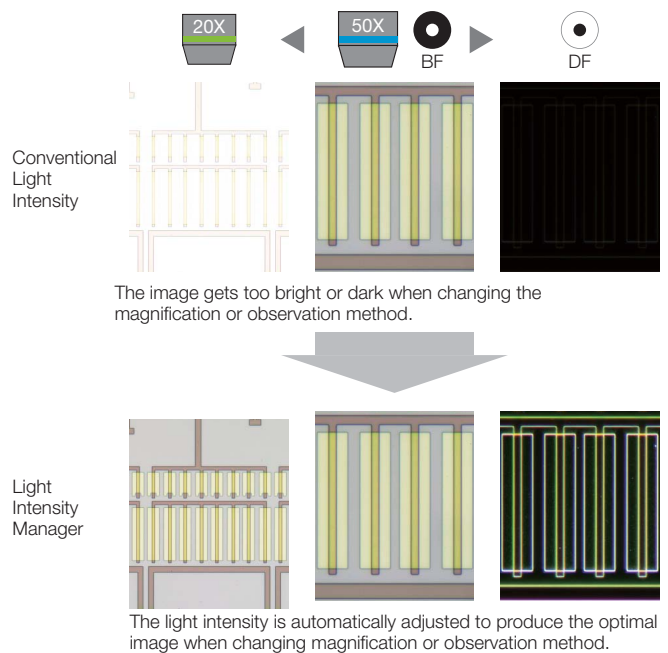

Ergonomic Controls for Quicker, More Comfortable Operation

The controls for changing the objective and adjusting the aperture stop are positioned low and in the front of the microscope so users don't have to let go of the focusing knobs or move their head away from the eyepieces during use.



Centralized microscope operation

Hand switch

Snapshot button

Advanced Imaging Technology

Exquisite optics and digital imaging for quality inspections

Olympus history of developing high-quality optics and advanced digital imaging capability have resulted in a record of proven optical quality and microscopes that offer good measurement accuracy.

Exceptional Optical Performance: Wave Front Aberration Control

The optical performance of objective lenses directly impacts the quality of the observation images and analysis results. Olympus UIS2 high-magnification objectives are designed to minimize wavefront aberrations, delivering reliable optical performance.

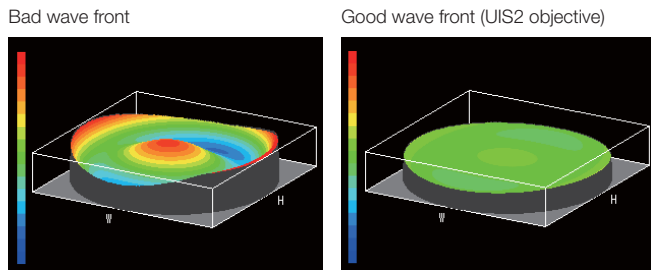

Consistent Color Temperature: High-Intensity White LED Illumination

The MX63 series utilizes a high-intensity white LED light source for reflected and transmitted illumination. The LED maintains a consistent color temperature regardless of intensity for reliable image quality and color reproduction. The LED system provides efficient, long-life illumination that is ideal for materials science applications.

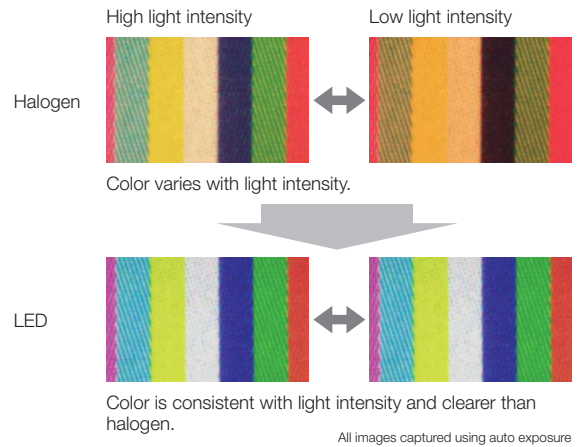

Precise Measurements: Auto Calibration



Similar to digital microscopes, automatic calibration is available when using OLYMPUS Stream software. Auto calibration helps eliminate human variability in the calibration process, leading to more reliable measurements. Auto calibration uses an algorithm that automatically calculates the correct calibration from an average of multiple measurement points. This minimizes variance introduced by different operators and maintains consistent accuracy, improving reliability for regular verification.

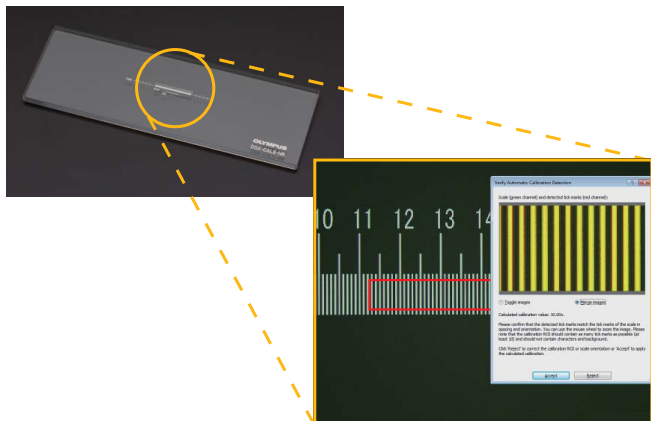

Entirely Clear Image: Image Shading Correction



OLYMPUS Stream software features shading correction to accommodate for shading around the corners of an image. When used with intensity threshold settings, shading correction provides a more precise analysis.

Semiconductor wafer (Binarized image)

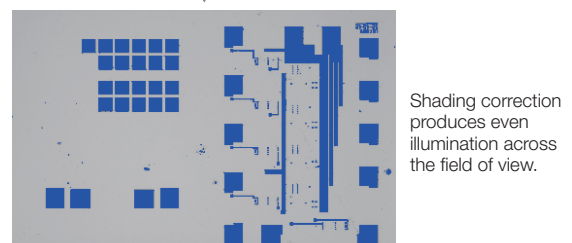

Applications

Reflected light microscopy spans a range of applications and industries. These are just a selection of examples of what can be achieved using different observation methods.

Darkfield / MIX with Brightfield IC pattern on a semiconductor wafer

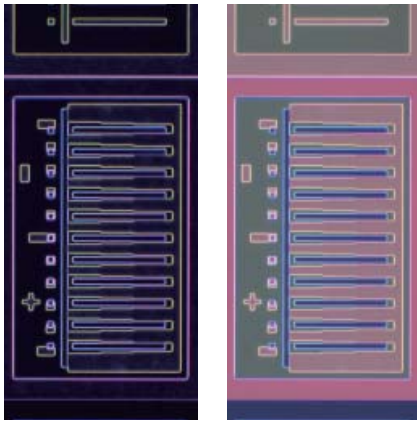

DF

MIX: BF+DF

Darkfield is used to observe scattered or diffracted light from a sample. As only things that are not flat reflect this light, imperfections clearly stand out. Inspectors can identify even minute flaws. Darkfield is ideal for detecting minute scratches or flaws on a sample and examining mirror surface samples, including wafers.

● The MIX function of BF/DF enables the observation of both the IC pattern and wafer color.

Fluorescence / MIX with Darkfield Photoresist residue on a semiconductor wafer

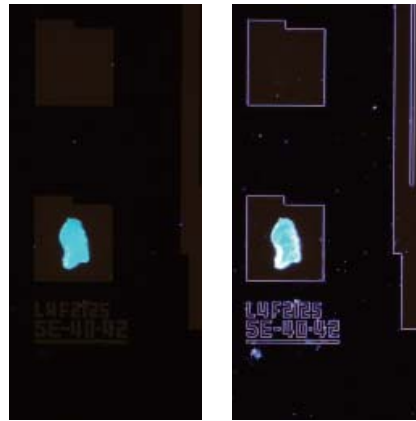

FL

MIX: FL+DF

This technique is used for samples that fluoresce (emit light of a different wavelength) when illuminated with a specially designed filter cube that can be selected to the specific application. It is suitable for inspection of contamination on semiconductor wafers, photoresist residues, and detection of cracks through the use of fluorescent dye.

● The MIX function of FL/DF enables the observation of both the photoresist residue and IC pattern.

Transmitted Light / MIX with Brightfield LCD color filter

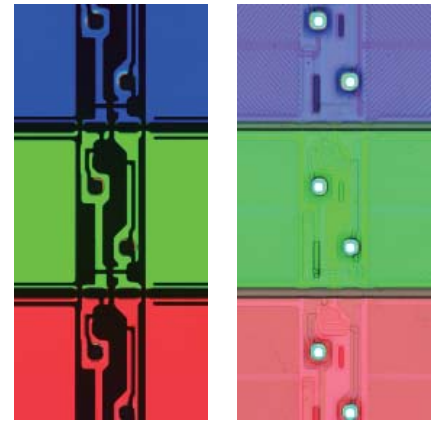

TL

MIX: TL+BF

This observation technique is suitable for transparent samples such as LCDs, plastics, and glass materials.

● The MIX function of TL/BF enables the observation of both the filter color and circuit pattern.

Differential Interference Contrast Hard disk

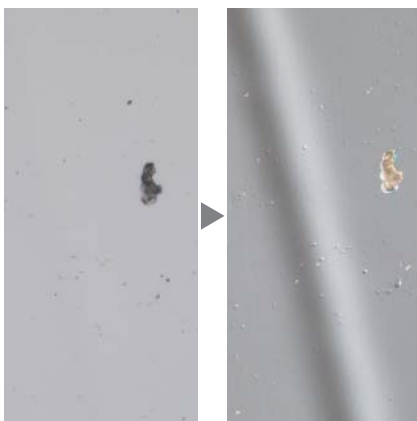

BF

DIC

Differential interference contrast (DIC) is an observation technique where the height of a sample, normally not detectable in brightfield, is visible as a relief, similar to a 3D image with improved contrast. It is ideal for inspections of samples having very minute height differences such as magnetic heads, hard-disk media, and polished wafers.

Polarized Light Film

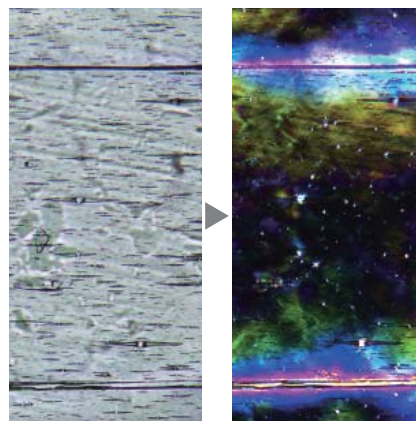

BF

POL

Polarized light observations represent a material's texture and crystal condition brightly. It is suitable for inspections of wafer and LCD structures.

Infrared (IR) Electrode section

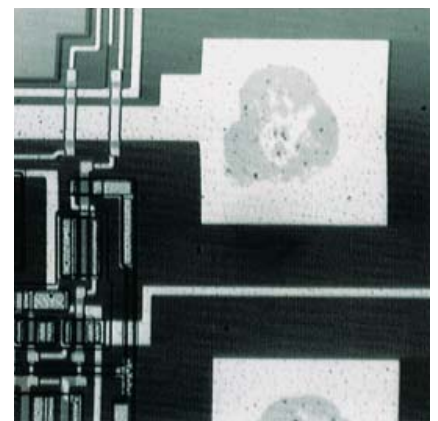

IR

IR observation is suitable for nondestructive inspections of defects inside IC chips and other electronic devices constructed with silicon or glass that easily transmit IR wavelengths of light.

Modular

Fully Customizable

The MX63 series is designed to enable the customer to choose a variety of optical components to suit individual inspections and application needs. The system can utilize all observation methods. Users can also select from a variety of OLYMPUS Stream image analysis packages to suit individual image acquisition and analysis needs.

Two Systems Accommodate Diverse Sample Sizes

The MX63 system can accommodate wafers up to 200 mm while the MX63L system can handle wafers up to 300 mm with the same small footprint as the MX63 system. The modular design of the MX63 series makes it easy to customize the microscope for your specific requirements.



MX63



MX63L

IR Compatibility

Infrared observation can be conducted with the IR objective lenses, which enable the operators to nondestructively inspect the inside of IC chips packed and mounted on a PCB, utilizing the characteristics of silicon that transmit infrared light. 5X to 100X IR objectives are available with chromatic aberration correction from visible light wavelengths through the near infrared.



IR objectives

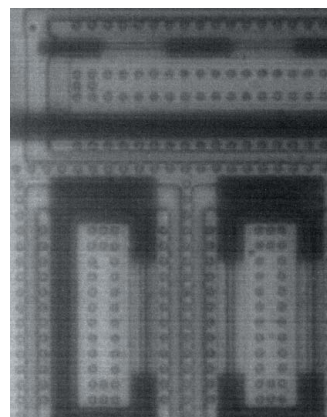

Normal image

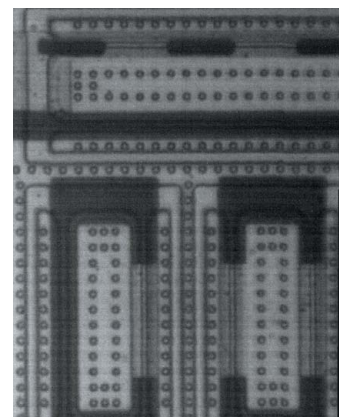

Image with chromatic aberration correction

Build Your System Your Way

Microscope frames

There are two microscope frames; one holds wafers up to 200 mm and the other holds wafers up to 300 mm. Accessories such as focus assist function and breath shield that can increase your inspection efficiency.

Microscope frames

		Stage configuration		
		360 mm x 300 mm	210 mm x 210 mm	150 mm x 150 mm
	■: Possible			
1	MX63L-F	■		
2	MX63-F		■	■

Accessories

3	MX-BSH-ESD-2	Breath shield to prevent wafer contamination
4	MX-FA	Built-in accessory to assist focusing on a sample
-	COVER-024	Dust cover for MX63/MX63L systems



Tubes

For viewing images through the eyepieces or for making observations via a camera, select the tubes by imaging type and the operator's posture during observation.

		FN (mm)	Type	Angle type	Image	The light amount ratio at the time of switching the optical path Eyepiece: Camera		
1	U-BI30-2*	22	Binocular	Fixing	Reverse	-	-	-
2	U-TBI-3*	22	Binocular	Tilting	Reverse	-	-	-
3	U-TR30-2*	22	Trinocular	Fixing	Reverse	100: 0	20: 80	0: 100
4	U-TR30-IR*	22	Trinocular for IR	Fixing	Reverse	100: 0	0: 0	0: 100
5	U-ETR-4	22	Trinocular	Fixing	Erect	100: 0	-	0: 100
6	U-TTR-2	22	Trinocular	Tilting	Reverse	100: 0	50: 50	0: 100
7	U-SWTR-3	26.5	Trinocular	Fixing	Reverse	100: 0	20: 80	0: 100
8	U-SWETTR-5	26.5	Trinocular	Tilting	Erect	100: 0	20: 80	-
9	MX-SWETTR	26.5	Trinocular	Tilting	Erect	100: 0	-	0: 100
10	U-TLU	22	Single port	-	-	-	-	-
11	U-TLUIR	22	Single port for IR	-	-	-	-	-

*Diopter adjustment mechanism of left eye side is available.



Eyepieces

Eyepieces enable users to view directly through the microscope. Select based on desired field of view.

		FN (mm)	Diopter adjustment mechanism	Built-in cross reticle
■: Possible				
1	WHN10X	22		
2	WHN10X-H	22	■	
3	CROSS WHN10X	22	■	■
4	SWH10X-H	26.5	■	
5	CROSS SWH10X	26.5	■	■



Stages

Stages and stage plates enable placement of the sample; select based on your sample's size and shape.

360 mm × 300 mm stage configuration

1	MX-SIC1412R2	Stage with built-in-clutch handle; 356 mm × 305 mm stroke
2	MX-WHPR128	12 - 8 in. rotatable wafer holder and plate
3	MX-SPG1412	306 mm × 420 mm stage glass plate
4	MX-MH6	6 in. × 6 in. mask holder

210mm × 210mm stage configuration

5	MX-SIC8R	Stage with built-in-clutch handle; 210 mm × 210 mm stroke
6	BH3-SP6	200 mm × 200 mm stage plate
7	BH3-SPG6	200 mm × 200 mm stage glass plate
8	MX-WHPR86	8 - 6 in. rotatable wafer holder and plate

150mm × 150mm stage configuration

9	MX-SIC6R2	Stage with built-in-clutch handle; 158 mm × 158 mm stroke
6	BH3-SP6	200 mm × 200 mm stage plate
10	BH3-WHP6	6 - 3 in. rotatable wafer holder plate
11	BH2-WHR43	4 - 3 in. rotatable wafer holder
12	BH2-WHR54	5 - 4 in. rotatable wafer holder
13	BH2-WHR65	6 - 5 in. rotatable wafer holder



Light Sources

Light sources and power supplies illuminate the sample. Choose the appropriate light source for the observation method.

Standard LED light source configuration

1	BX3M-LEDR	LED lamp housing for reflected light
---	-----------	--------------------------------------

FL light source configuration

2	MX-HGAD	High intensity light adapter
3	U-LLGAD	Liquid light guide adapter
4, 5	U-LLG150 (300)	Liquid light guide, length: 1.5 m (3 m)
6	U-HGLGPS	Light source for fluorescence, packed one SHI-1300L
-	SHI-1300L	130 W mercury lamp
7, 8	U-LH100HG (HGAP0)	Mercury lamp housing for fluorescence (Chromatic aberration correction type)
-	U-SH-1030L	100 W mercury lamp
9	U-CLA	Extension flexible handle for Mercury lamp housing
10	U-RFL-T	Power supply for 100 W mercury lamp
11	U-CST	Optical axis adjustment sample for mercury lamp housing

Halogen and Halogen IR light source configuration

12, 13	U-LH100L-3, (U-LH100IR)	Halogen lamp housing (for IR)
-	12V100W HAL (-L)	100 W halogen lamp (long life type)
14	U-RMT	Extender cable for halogen lamp housing, cable length 1.7 m (requires cable extension when necessary)
15, 16	TH4-100 (200)	100 V (200 V) specification power supply for 100 W/50 W halogen lamp
17	TH4-HS	Hand switch for light intensity of halogen (dimmer TH4-100 (200) without hand switch)

Double lamp housing configuration

18	U-DULHA	Dual lamp housing attachment
-	FL light source configuration	
-	Standard LED light source configuration	
19	U-RCV	Adapter for BX3M-LEDR
-	MX-LLHECBL	Extension cable for BX3M-LEDR
-	Halogen light source configuration (not including for IR)	

Halogen light source configuration for transmitted light

20	LG-PS2	Halogen light source for transmitted light
-	JCR12V-100WB	100 W halogen lamp
21	LG-SF	Light guide for transmitted light, cable length 1m



Nosepieces

Attach the objectives and sliders. Select the nosepiece based on the number of objectives needed and types as well as whether or not a slider attachment is required.

	■: Possible	Type	Holes	BF	DF	DIC	MIX	Number of centering holes
1		Motorized	5	■	■	■	■	
2		Motorized	6	■		■		
3		Motorized	6	■	■	■	■	
4		Motorized	5	■		■		5
5		Motorized	5	■	■	■	■	4

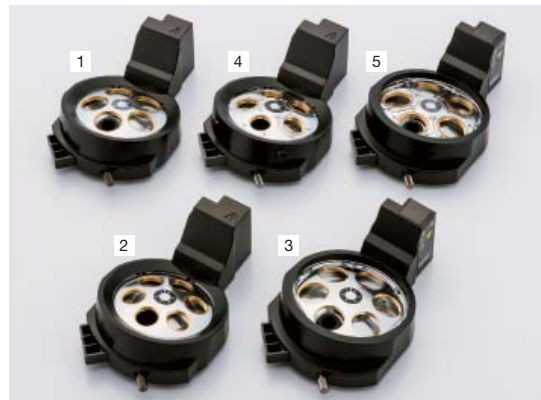

Sliders

Select the slider to complement traditional brightfield observation. The DIC slider provides topographic information about the sample with options to maximize contrast or resolution. The MIX slider provides illumination flexibility with a segmented LED source in the darkfield path.

	Type	Amount of shear	Available objectives
1	U-DICR	Standard	MPLFLN, MPLAPON, LMPLFLN, and LCPLFLN-LCD
2	U-DICRH	Resolution	MPLFLN, MPLAPON
3	U-DICRHC	Contrast	LMPLFLN and LCPLFLN-LCD



MIX slider for MIX observation.

	Type	Available objectives
4	U-MIXR	MPLFLN-BD, LMPLFLN-BD, MPLN-BD

Cable

-	U-MIXRCBL-1-2	U-MIXR cable, Cable length: 0.5 m
---	---------------	-----------------------------------

Hand Switches

Hand switches enable hardware display and control.

Hand switch

1	BX3M-HS	MIX observation control, indicator of coded/motorized hardware, programmable function button of software (OLYMPUS Stream)
2	U-HSEXP	Shutter operation of camera



Camera Adapters

Adapters for camera observation. Select based on the required field of view and magnification. The actual observation range can be calculated using this formula: actual field of view (diagonal mm) = viewing field (viewing number) ÷ objective magnification.

	Magnification	Centering adjustment (mm)	CCD image area (field number) (mm)			
			2/3 in.	1/1.8 in.	1/2 in.	
1	U-TV1X-2 with U-CMAD3	1	-	10.7	8.8	8
2	U-TV1XC	1	ø2	10.7	8.8	8
3	U-TV0.63XC	0.63	-	17	14	12.7
4	U-TV0.5XC-3	0.5	-	21.4	17.6	16
5	U-TV0.35XC-2	0.35	-	-	-	22
6	U-TV0.25XC*	0.25	-	-	-	-

For information on digital cameras, please visit our website at <http://www.olympus-ims.com/en/microscope/dc/>



Optical Filters

Optical filters convert sample exposure light to different types of illumination. Select the appropriate filter for the observation requirements.

BF, DF, FL

1, 2, 3	U-25ND50, 25, 6	Transmittance 50%/25%/6%
4	U-25LBD	Daylight color filter
5	U-25LBA	Halogen color filter
6	U-25IF550	Green filter
7	U-25L42	UV cut filter, cuts the ultraviolet ray to prevent the tarnish on the polarizer caused by the mercury lamp housing.
8	U-25Y48	Yellow filter
9	U-25FR	Frost filter

POL, DIC

10	U-AN360-3	Analyzer for reflected, polarization direction is 360 degree rotatable.
11	U-PO3	Polarizer for transmitted, polarization direction is fixed.

Other

12	U-25	Empty filter, used by combining customer's ø25 mm filters
----	------	---



IR

13	U-BP1100IR	Band pass filter: 1100 nm
14	U-BP1200IR	Band pass filter: 1200 nm

Transmitted light

15	25LBD	ø25 mm daylight color filter
16, 17	25ND25, 6	ø25 mm transmittance 25%/6%
18	30.5S-LBD	ø30.5 mm daylight color filter

Mirror Units

Mirror unit for the MX63/MX63L. Select the unit for required observation.

1	U-MDIC3	For POL, cross nicol condition is fixed.
2	U-MDICA3	Polarizer for reflected, polarization direction is fixed, analyzer is none.
3	U-MDICT3	Analyzer for transmitted, polarization direction is fixed, polarizer is none.
4	U-MWUS	For ultraviolet FL: BP 330 - 385 nm, BA 420 nm, DM 400 nm
5	U-MWBS	For blue FL: BP 460 - 490 nm, BA 520 nm, DM 500 nm
6	U-MWGS	For green FL: BP 510 - 550 nm, BA 590 nm, DM 570 nm
7	U-MF2	Empty mirror unit, used customer's optical element



Transmitted illumination unit

Condensers collect and focus transmitted light and are used for transmitted light observation.

1	MX-TILLA	Standard type (built in AS), available for 5× objectives and above, NA: 0.5
2	MX-TILLB	High resolution type (built in AS and FS), available for 5× objectives and above, NA: 0.6, vertical movement adjustment function of condenser



Intermediate Tubes

Various types of accessories for multiple purposes that go between the tube and illuminator.

1	U-CA	Magnification changer (1×, 1.25×, 1.6×, 2×)
2	U-ECA	Magnification changer (1×, 2×)
3	U-EPA2	Eye point adjuster : + 30 mm
4	U-DP	Dual port for U-DP1XC
5	U-DP1XC	C-mount TV camera adapter for U-DP



UIS2 Objectives

Objectives magnify the sample. Select the objective that matches the working distance, resolving power, and observation method for the application.

Objectives	Magnifications	NA	W.D. (mm)	Cover Glass Thickness ^{*3} (mm)	Resolution ^{*4} (μm)
MPLAPON	1 50X	0.95	0.35	0	0.35
	2 100X	0.95	0.35	0	0.35
	3 1.25X ^{*5} *6	0.04	3.50	0-0.17	8.39
	4 2.5X ^{*8}	0.08	10.70	0-0.17	4.19
MPLFLN	5 5X	0.15	20.00	0-0.17	2.24
	6 10X	0.30	11.00	0-0.17	1.12
	7 20X	0.45	3.10	0	0.75
	8 40X ^{*2}	0.75	0.63	0	0.45
	9 50X	0.80	1.00	0	0.42
	10 100X	0.90	1.00	0	0.37
SLMPLN	11 20X	0.25	25.00	0-0.17	1.34
	12 50X	0.35	18.00	0	0.96
	13 100X	0.60	7.60	0	0.56
LMPLFLN	14 5X	0.13	22.50	0-0.17	2.58
	15 10X	0.25	21.00	0-0.17	1.34
	16 20X	0.40	12.00	0	0.84
MPLN ^{*5}	17 50X	0.50	10.60	0	0.67
	18 100X	0.80	3.40	0	0.42
	19 5X	0.10	20.00	0-0.17	3.36
LCPLFLN-LCD	20 10X	0.25	10.60	0-0.17	1.34
	21 20X	0.40	1.30	0	0.84
	22 50X	0.75	0.38	0	0.45
MPLFLN-BD ^{*7}	23 100X	0.90	0.21	0	0.37
	24 20X	0.45	8.30-7.40	0-1.2	0.75
	25 50X	0.70	3.00-2.20	0-1.2	0.48
MPLFLN-BDP ^{*7}	26 100X	0.85	1.20-0.90	0-0.7	0.39
	27 5X	0.15	12.00	0-0.17	2.24
	28 10X	0.30	6.50	0-0.17	1.12
LMPLFLN-BD ^{*7}	29 20X	0.45	3.00	0	0.75
	30 50X	0.80	1.00	0	0.42
	31 100X	0.90	1.00	0	0.37
MPLN-BD ^{*5} *7*8	32 150X	0.90	1.00	0	0.37
	33 5X	0.15	12.00	0-0.17	2.24
	34 10X	0.25	6.50	0-0.17	1.34
MPLAPON	35 20X	0.40	3.00	0	0.84
	36 50X	0.75	1.00	0	0.45
	37 100X	0.90	1.00	0	0.37
MPLN-BD ^{*5} *7*8	38 5X	0.13	15.00	0-0.17	2.58
	39 10X	0.25	10.00	0-0.17	1.34
	40 20X	0.40	12.00	0	0.84
MPLN-BD ^{*5} *7*8	41 50X	0.50	10.60	0	0.67
	42 100X	0.80	3.30	0	0.42
	43 5X	0.10	12.00	0-0.17	3.36
MPLN-BD ^{*5} *7*8	44 10X	0.25	6.50	0-0.17	1.34
	45 20X	0.40	1.30	0	0.84
	46 50X	0.75	0.38	0	0.45
MPLAPON	47 100X	0.90	0.21	0	0.37
	100XOil ^{*1}	1.40	0.10	0	0.24



Objectives	Magnifications	NA	W.D. (mm)	Cover Glass Thickness (mm)	Silicon Thickness (mm)	Resolution ^{*4} (μm)
LMPLN-IR ^{*9}	48 5X	0.1	23	0-0.17	-	6.71 ^{*10}
	49 10X	0.3	18	0-0.17	-	2.24 ^{*10}
LCPLN-IR ^{*9}	50 20X	0.45	8.3	0-1.2	0-1.2	1.49 ^{*10}
	51 50X	0.65	4.5	0-1.2	0-1.2	1.03 ^{*10}
	52 100X	0.85	1.2	0-0.7	0-1.0	0.79 ^{*10}

- *1 Specified oil: IMMOIL-F30CC/IMMOIL-8CC/IMMOIL-500CC/IMMOIL-F30CC
 - *2 The MPLFLN40X objective is not compatible with the differential interference contrast microscopy
 - *3 0: For viewing specimens without a cover glass
 - *4 Resolutions calculated with aperture iris diaphragm wide open
 - *5 Limited up to FN 22, no compliance with FN 26.5
 - *6 Analyzer and polarizer are recommended for usage with MPLFLN1.25X and 2.5X
 - *7 BD: Brightfield/Darkfield objectives
 - *8 Slight vignetting may occur in the periphery of the field when MPLN-BD series objectives are used with high-intensity light sources such as mercury and xenon for darkfield
- Observation**
- *9 Limited up to FN 22, not compatible with FN 26.5
 - *10 With the use of 1100 nm

■ Definition for Objective Lens Abbreviations

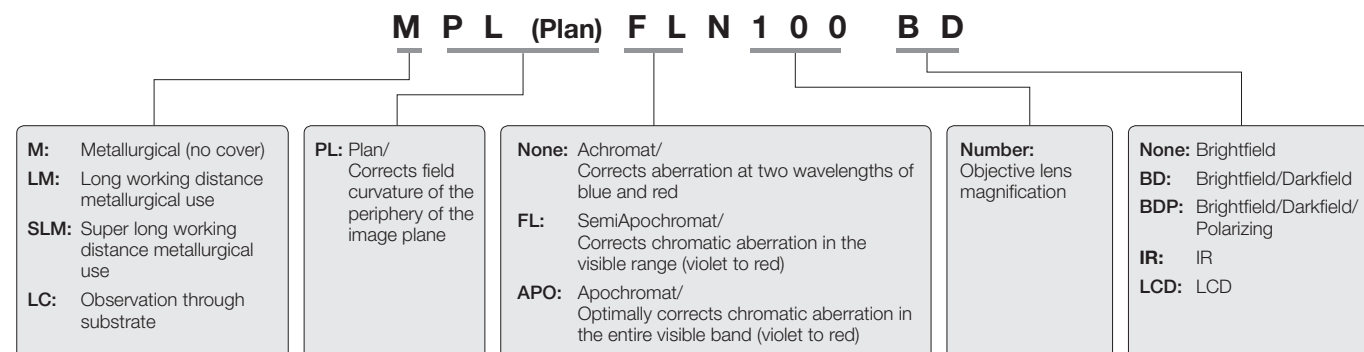

MX63 / MX63L System Diagram

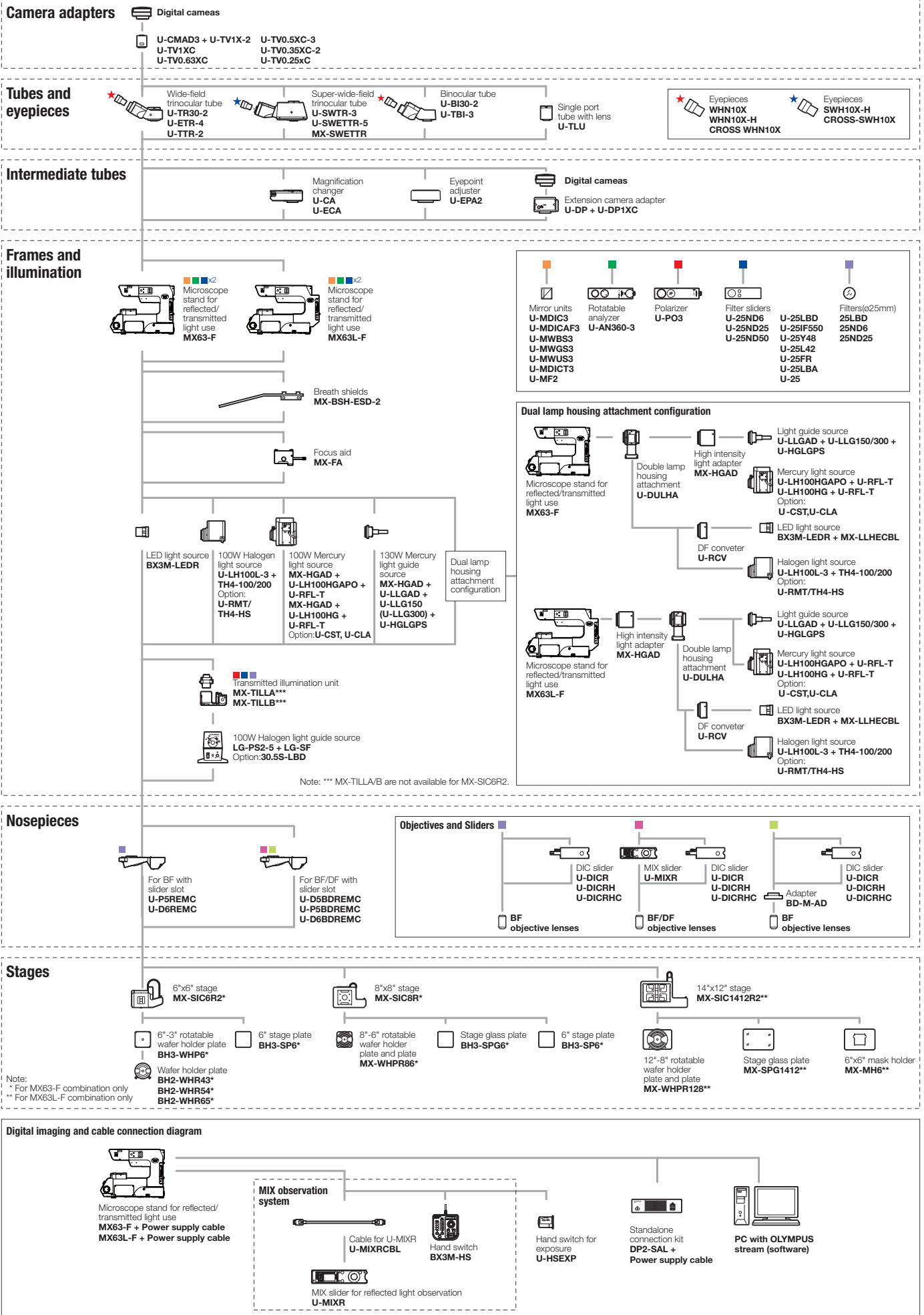

MX63 / MX63L System Diagram (IR Observation)

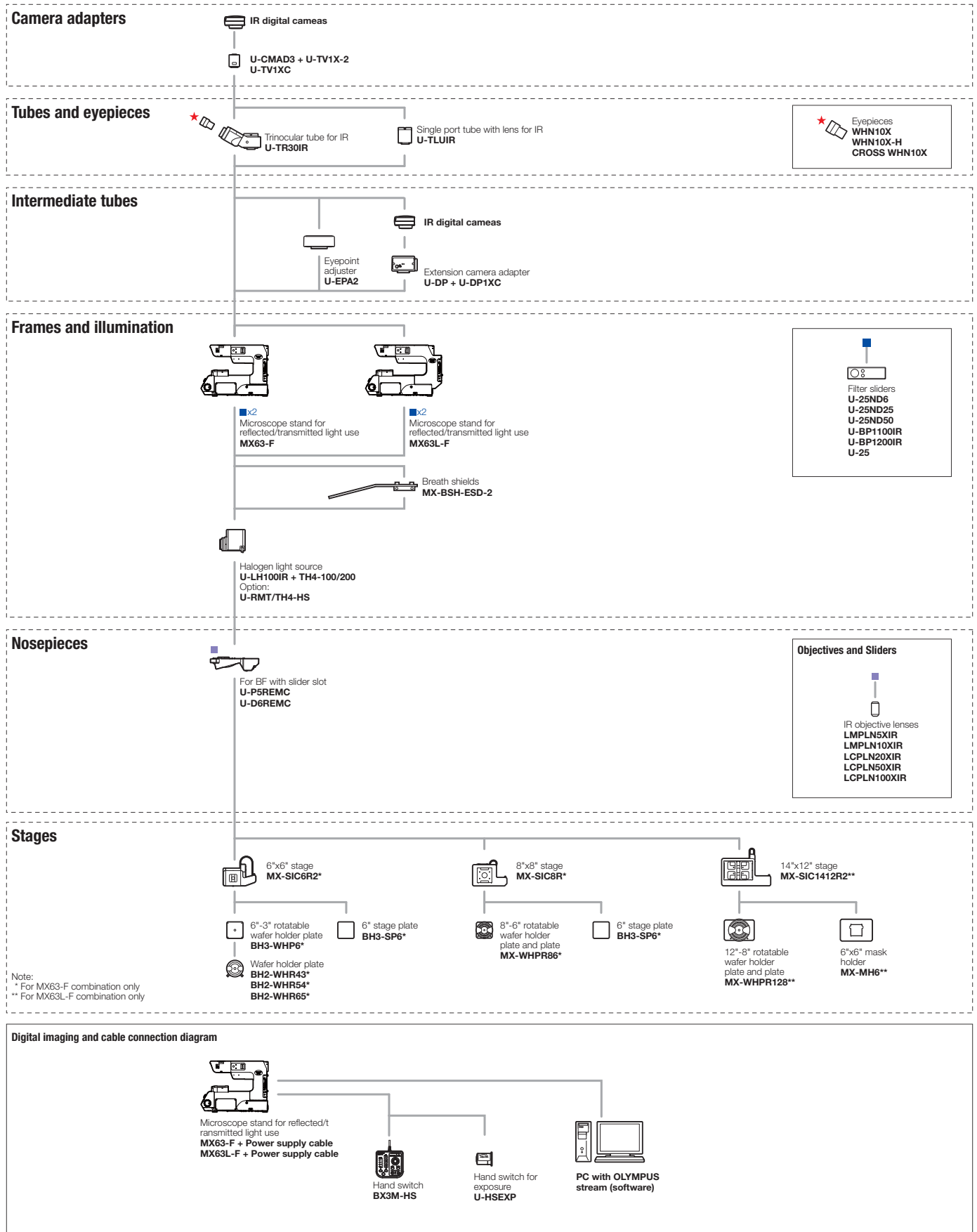

Specifications

		MX63	MX63L
Optical system		UIS2 optical system (infinity-corrected system)	
Microscope frame	Reflected light illumination	White LED (with Light Intensity Manager) 12 V 100 W halogen lamp, 100 W mercury lamp Brightfield/darkfield/mirror cube manual changeover. (Mirror cube is optional.) 3 position coded mirror units changed by manual operation Built-in motorized aperture diaphragm (Pre-setting for each objective, automatically full open for darkfield) Observation mode: brightfield, darkfield, differential interface contrast (DIC)* ¹ , simple polarizing* ¹ , fluorescence* ¹ , infra-red* ¹ and MIX observation (4 directional darkfield) * ¹ Optional mirror cube, * ² MIX observation configuration is required.	
	Transmitted light illumination	Transmitted light illumination unit: MX-TILLA or MX-TILLB is required. - MX-TILLA: a condenser (NA 0.5) and an aperture stop - MX-TILLB: a condenser (NA 0.6), an aperture stop and a field stop Light source: LG-PS2 (12 V, 100 W halogen lamp) Light guide: LG-SF Observation mode: brightfield, simple polarizing	
	Electrical system	Reflected light illumination Built-in LED power supply for reflected light illumination Continuously-variable light intensity dial Input rating 100-120 V/220-240 V AC 1.9/0.9A, 50Hz/60Hz	
		Transmitted light illumination Light source LG-PS2 (12 V 100 W) Continuously-variable light intensity dial Input rating 100-120 V/220-240 V AC 3.0/1.8A 50/60Hz	
		External interface Motorized revolving nosepiece connector x1, Handset (BX3M-HS) connector x1, Handset (U-HSEXP) connector x1, MIX Slider (U-MIXR) connector x1, RS232 connector x1, USB2.0 connector x1	
	Focus	Stroke: 32 mm Fine stroke per rotation: 100 μm Minimum graduation: 1 μm Upper limit stopper and torque adjustment for coarse handle	
Maximum load weight (including stage and holder)	8 kg	15 kg	
Observation tube	Wide-field (FN 22 mm)	Elect and trinocular: U-ETR4 Elect, tilting and trinocular: U-TTR-2 Inverted and trinocular: U-TR30-2, U-TR30IR (for IR observation) Inverted and binocular: U-BI30-2 Inverted, tilting and binocular: U-TBI30	
	Super-wide-field (FN 26.5 mm)	Elect, tilting and trinocular: MX-SWETTR (optical path switchover 100% (eyepiece) : 0 (camera) or 0 : 100%) Elect, tilting and trinocular: U-SWETTR (optical path switchover 100% (eyepiece) : 0 (camera) or 20% : 80%) Inverted and trinocular: U-SWTR-3	
Motorized nosepiece	Brightfield Motorized sextuple with a slider slot for DIC: U-D6REMC Motorized centerable quintuple with a slider slot for DIC: U-P5REMC Brightfield and darkfield Motorized sextuple with a slider slot for DIC: U-D6BDREMC Motorized quintuple with a slider slot for DIC: U-D5BDREMC Motorized centerable quintuple with a slider slot for DIC: U-P5BDREMC		
Stage (X × Y)	Coaxial right handle with built-in clutch drive: MX-SIC8R Stroke: 210 × 210 mm Transmitted light illumination area: 189 × 189 mm Coaxial right handle with built-in clutch drive: MX-SIC6R2 Stroke: 158 × 158 mm (Reflected light use only)	Coaxial right handle with built-in clutch drive: MX-SIC1412R2 Stroke: 356 × 305 mm Transmitted light illumination area: 356 × 284 mm	
Weight	Approx. 35.6 kg (Microscope frame 26 kg)		Approx. 44 kg (Microscope frame 28.5 kg)
Environment	<ul style="list-style-type: none"> •Indoor use •Ambient temperature: 10 to 35 °C (50 to 95 °F) •Maximum relative humidity: 80% for temperatures up to 31 °C (88 °F) (without condensation) In case of over 31 °C (88 °F), the relative humidity is decreased linearly through 70% at 34 °C (93 °F), 60% at 37 °C (99 °F), and to 50% at 40 °C (104 °F). •Supply voltage fluctuation: ±10 % 		

Dimensions

MX63

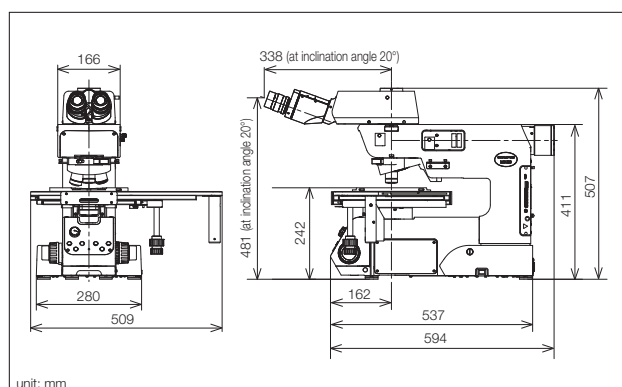

MX63L

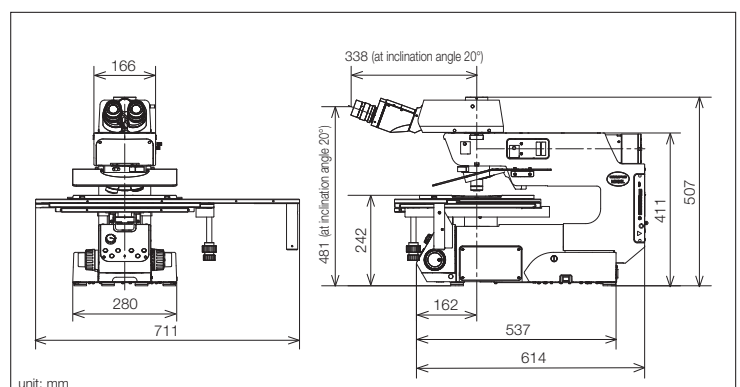

Olympus offers an extensive product line for materials science and industrial microscopy. Learn more about the LEXT 3D measuring laser microscope and DSX series digital microscope on our website, www.olympus-ims.com.



NEW

LEXT 3D Measuring Laser Microscope

Power and speed are the hallmarks of the LEXT OLS5000 microscope. Owing to its high-resolution imaging and fast acquisition, the microscope delivers precise non-contact 3D observations and measurement of surface topography with impressive efficiency.



DSX Digital Microscope

The DSX microscope's advanced digital technology delivers superior image quality with superb operating simplicity, making it perfect for users of any experience level. The microscope's intelligent interface is as simple as using a smartphone or tablet and backed by guaranteed accuracy and repeatability for 2D and 3D measurements.

www.olympus-ims.com

OLYMPUS[®]

OLYMPUS CORPORATION
Shinjuku Monolith, 2-3-1 Nishi-Shinjuku, Shinjuku-ku, Tokyo 163-0914, Japan

- OLYMPUS CORPORATION is ISO14001 certified.
- OLYMPUS CORPORATION is ISO9001 certified.
- This product is designed for use in industrial environments for the EMC performance. Using it in a residential environment may affect other equipment in the environment.
- All company and product names are registered trademarks and/or trademarks of their respective owners.
- Images on the PC monitors are simulated.
- Specifications and appearances are subject to change without any notice or obligation on the part of the manufacturer.
- Illumination devices for microscope have suggested lifetimes. Periodic inspections are required. Please visit our web site for details.

N8600790-092017